



upcomillas *es*

upcomillas *es*

Simulation of IEC 61850-based substations under OMNeT++

Javier Juárez, Carlos Rodríguez-Morcillo,
José Antonio Rodríguez-Mondéjar

23rd March 2012



Index



- Introduction.
- IEC 61850.
- Advanced Simulation Platform.
- Hardware-in-the-loop simulation.
- Conclusions.

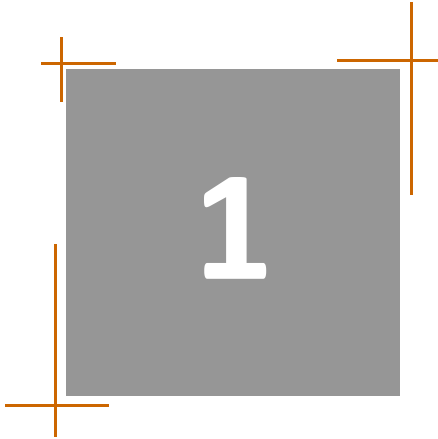

Introduction

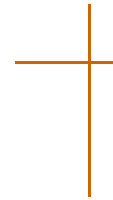

Introduction

Smart Grid

- The Smart Grid implies an evolution of the electrical network focusing on its technical infrastructure.
- The basic concept of Smart Grid is to add monitoring, analysis, control, and communication capabilities.
- It is a complex system where communication networks play a major role.
- Advanced simulation platforms are required to facilitate the study, analysis, design and evaluation of such systems.

Introduction

IEC 61850

- One of the main standards in the scope of Smart Grid communications is the IEC 61850.
- This standard is focused on the communications between intelligent electronic devices in power utility automation systems.
- Its main objective is to achieve interoperability between machines from different vendors.

Introduction

IEC 61850

- Initially, the scope of this standard was substation automation systems, but recently it has been extended to other areas of the Smart Grid, such as, distribution of energy resources.
- This standard is not easily understood.
- IEC 61850 substations are intricate and expensive systems.
- Having a platform that can be used as a test-bed for developing prototypes, applications or algorithms for such systems could be very advantageous.

Introduction

IEC 61850 Simulation

- Existing simulation platforms for IEC 61850-based systems are mainly focused on the evaluation of the performance and functionality of the communication network.
- The simulation platform presented here not only allows the analysis of network performance, but also to implement a test-bed that facilitates the development of prototypes, algorithms and designs.

Introduction

- This work presents a new IEC 61850 simulation platform.
- It is based on OMNeT++ and it not only allows to conduct a network performance analysis, but also to carry out hardware-in-the-loop simulations.
- Features of the simulation platform:
 - A **new simulation core** using two parallel processes has been developed.
 - A **real IEC 61850 communication stack** has been integrated into OMNeT++.

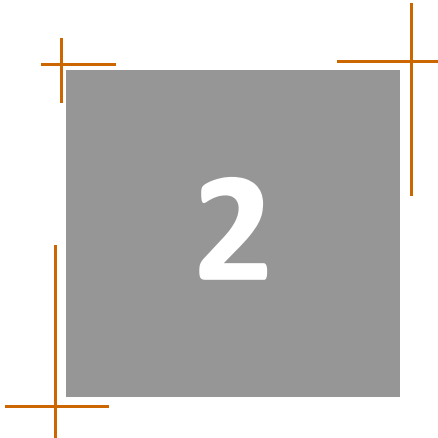

IEC 61850

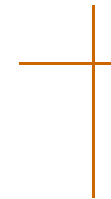

- The international standard IEC 61850 proposes a solution for the communication aspect of substation automation systems.
- IEC 61850 provides a layout of a virtualized model that represents the behavior of the devices in charge of controlling electric facilities.
- This data model is object-oriented and it is represented with a set of tables provided in IEC 61850 part 7.

- The standard has three central points.
 - Firstly, it defines the requirements of the IEC 61850-based communication systems.
 - Secondly, it establishes a solid data model and communication services.
 - Finally, it specifies a configuration language which facilitates the configuration of IEC 61850 devices.
- The standard separates the data model from communication services and the protocol stack .

IEC 61850

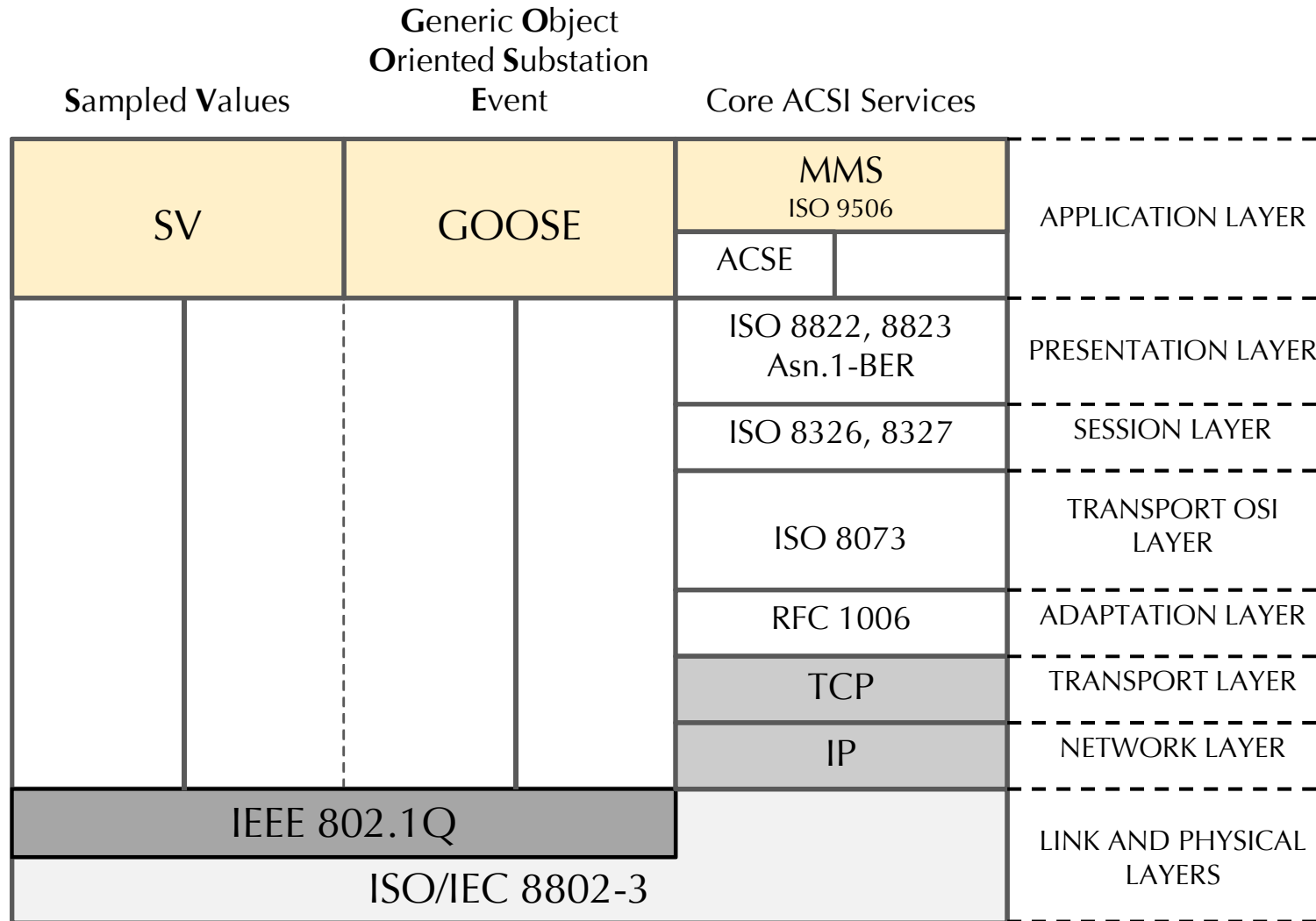

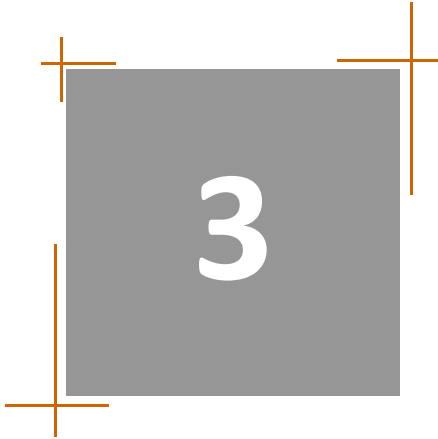

Advanced Simulation Platform

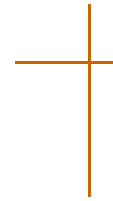

Advanced Simulation Platform

IEC 61850 simulation models

- ISO/IEC 8802-3 (with some modifications in order to support IEEE 802.1Q standard), TCP and IP layers have been imported from INETMANET framework.
- SV, GOOSEs, and high layers of MMS stack (from RFC 1006 layer to MMS application layer) have been integrated into OMNeT++ using an external library.
- This external library has been developed with open-source resources.

Advanced Simulation Platform IEC 61850 simulation models

- Merging Unit:
 - Device that functions as an interface between electronic measurement transformers and control and protection devices, by merging the sampled data of the measured values.

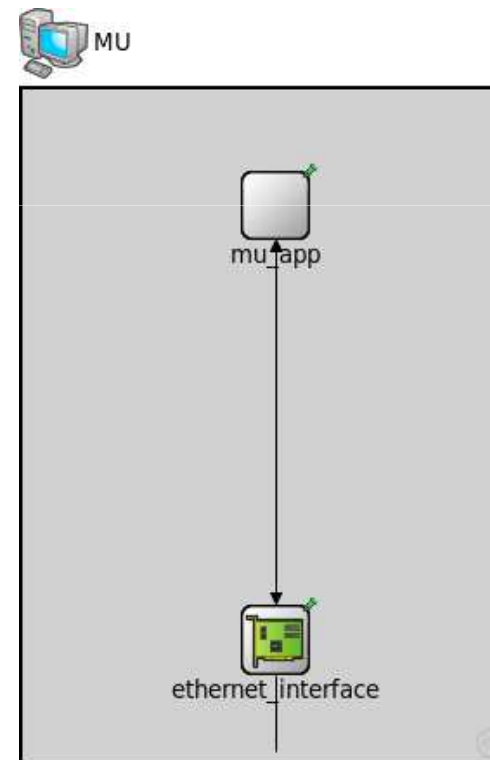
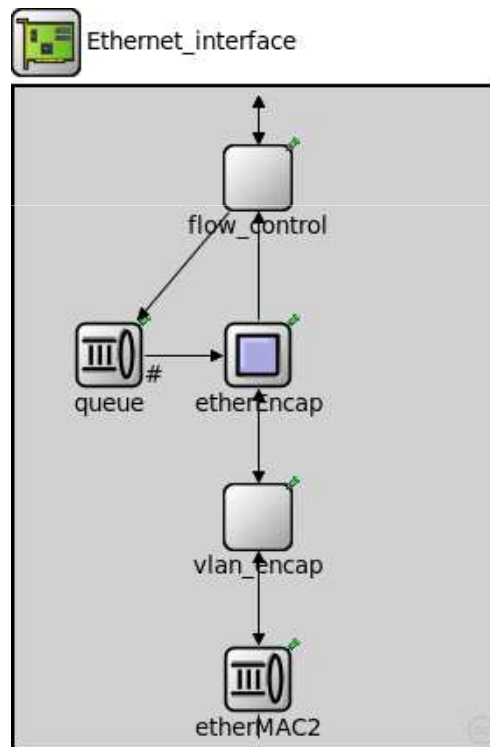

Advanced Simulation Platform IEC 61850 simulation models

- Generic Device:
 - Device for protection and control functions.

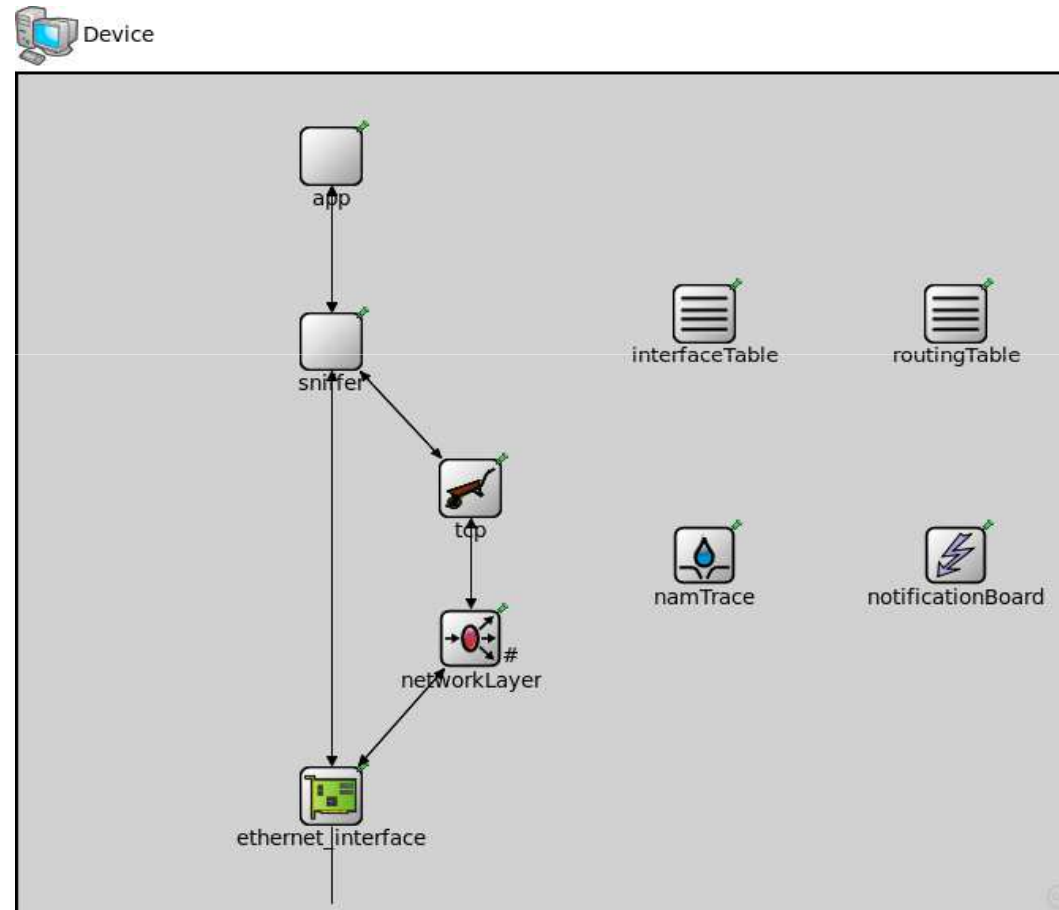

Advanced Simulation Platform

Simulation Core

- OMNeT++ has three schedulers defined, and allows the implementation of new ones.
 - CSequentialScheduler: the basic scheduler.
 - CRealTimeScheduler: it uses wait calls that synchronize the simulation time to the system clock.
 - CSocketRTScheduler: its behavior is similar to the real time scheduler, but during wait calls the scheduler waits for incoming messages from an external device using sockets.

Advanced Simulation Platform Simulation Core

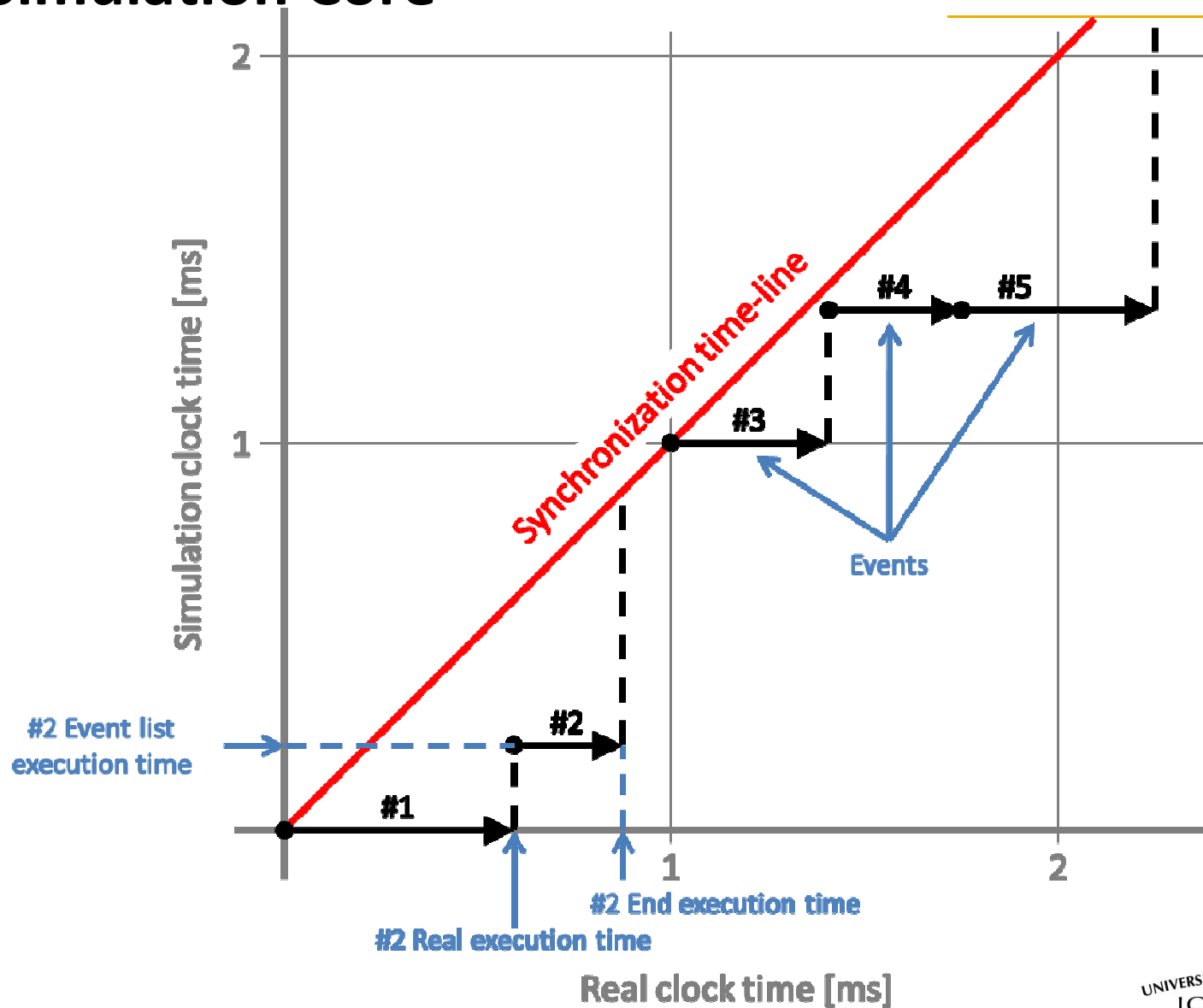

Advanced Simulation Platform Simulation Core

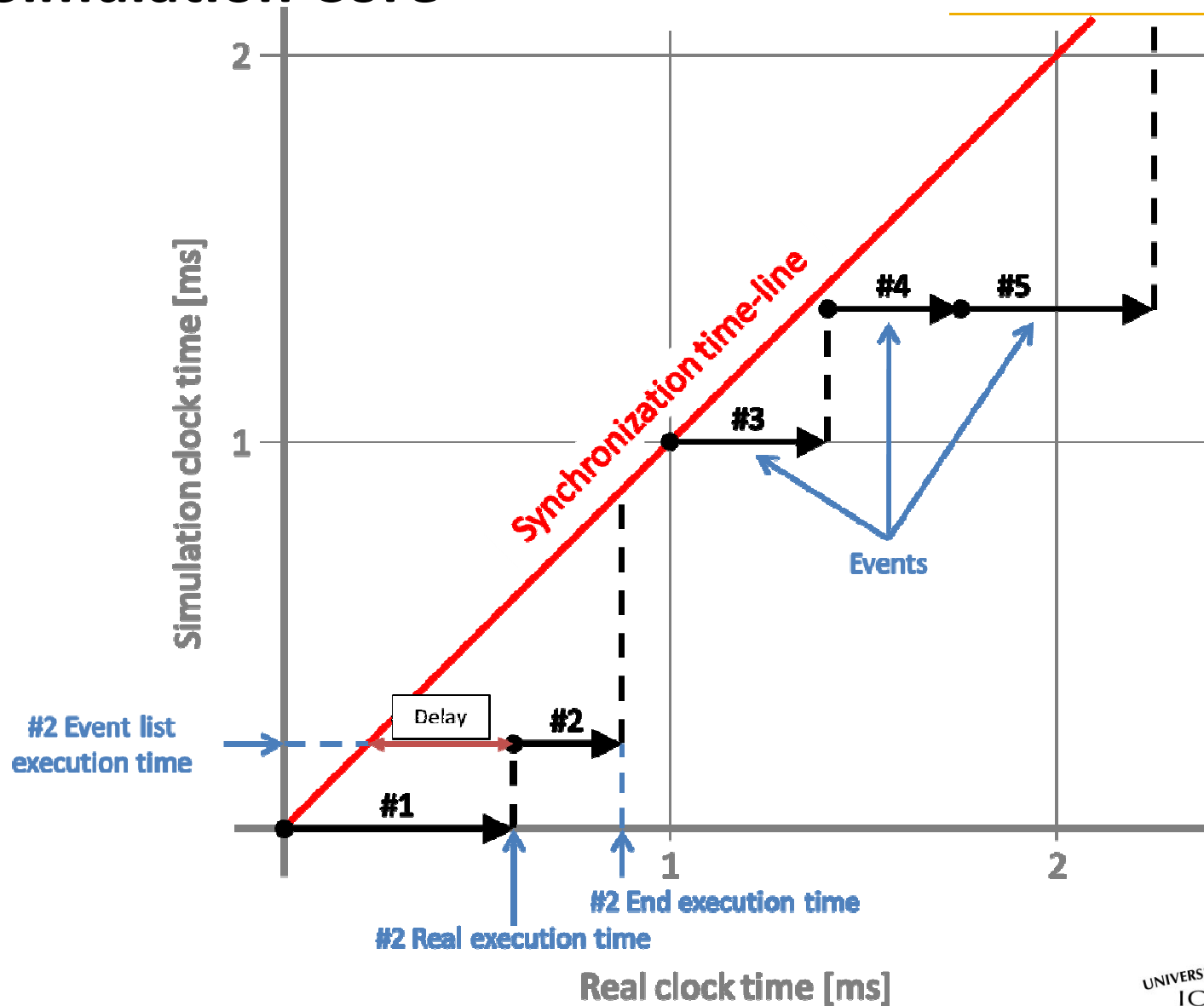

Advanced Simulation Platform

Simulation Core

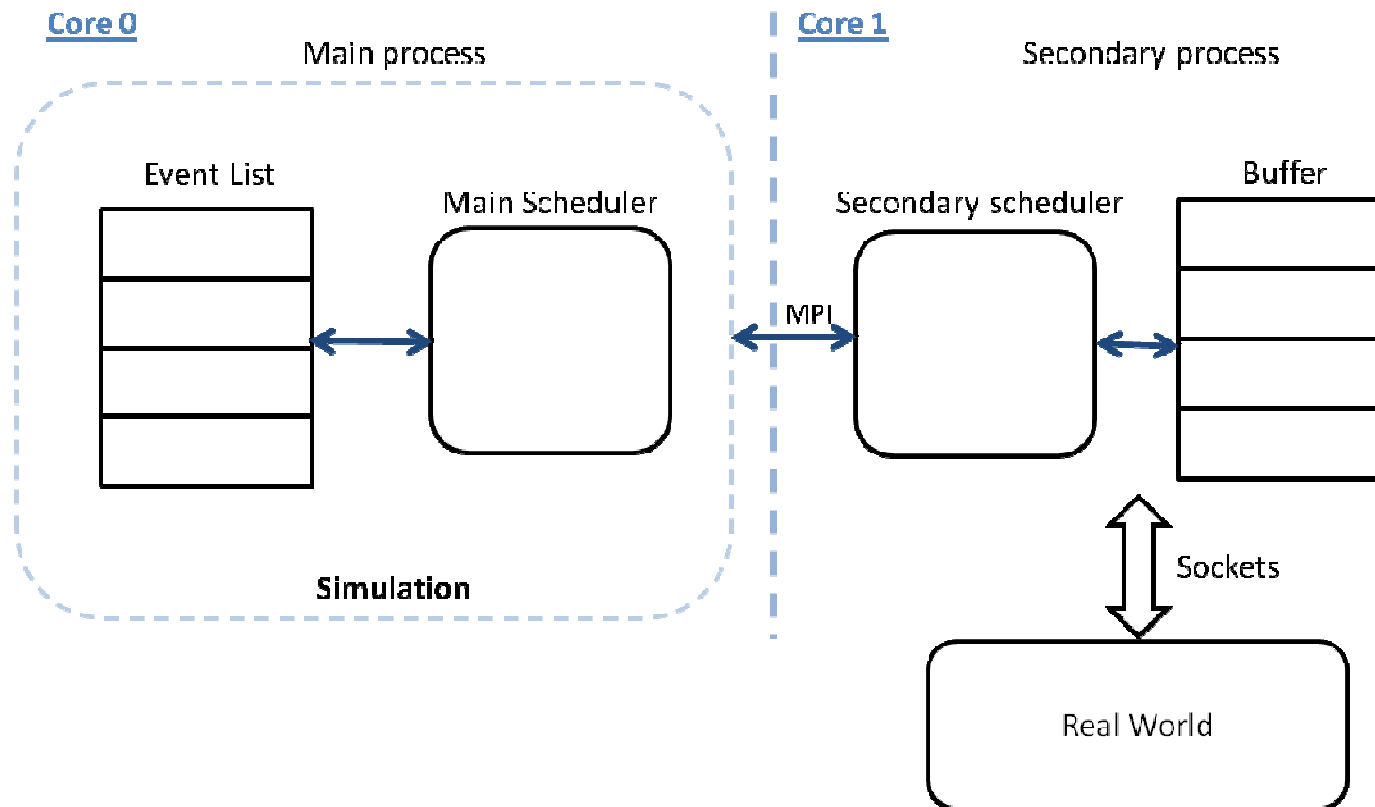

- The first process manages the main simulation, in other words, the event list and the main scheduler.
- The second process manages the connection with a real network.

Advanced Simulation Platform

Simulation Core

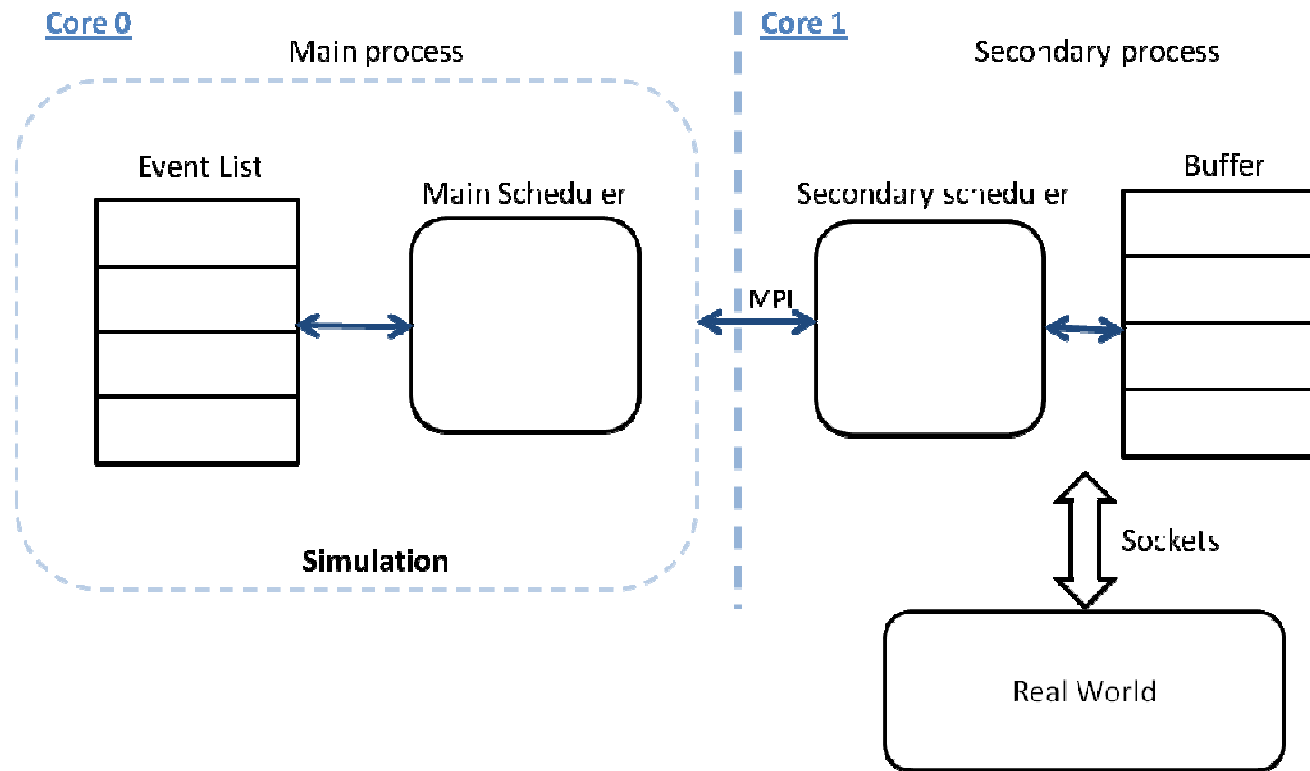

- The main scheduler behavior is similar to that of the cRealTimeScheduler, but it also monitors the messages that has to be exchanged with a real network.
- In the secondary process, when a message arrives from a real device, it is sent to the main process. If a message arrives from the main process it is sent to the real network.

Advanced Simulation Platform Simulation Core

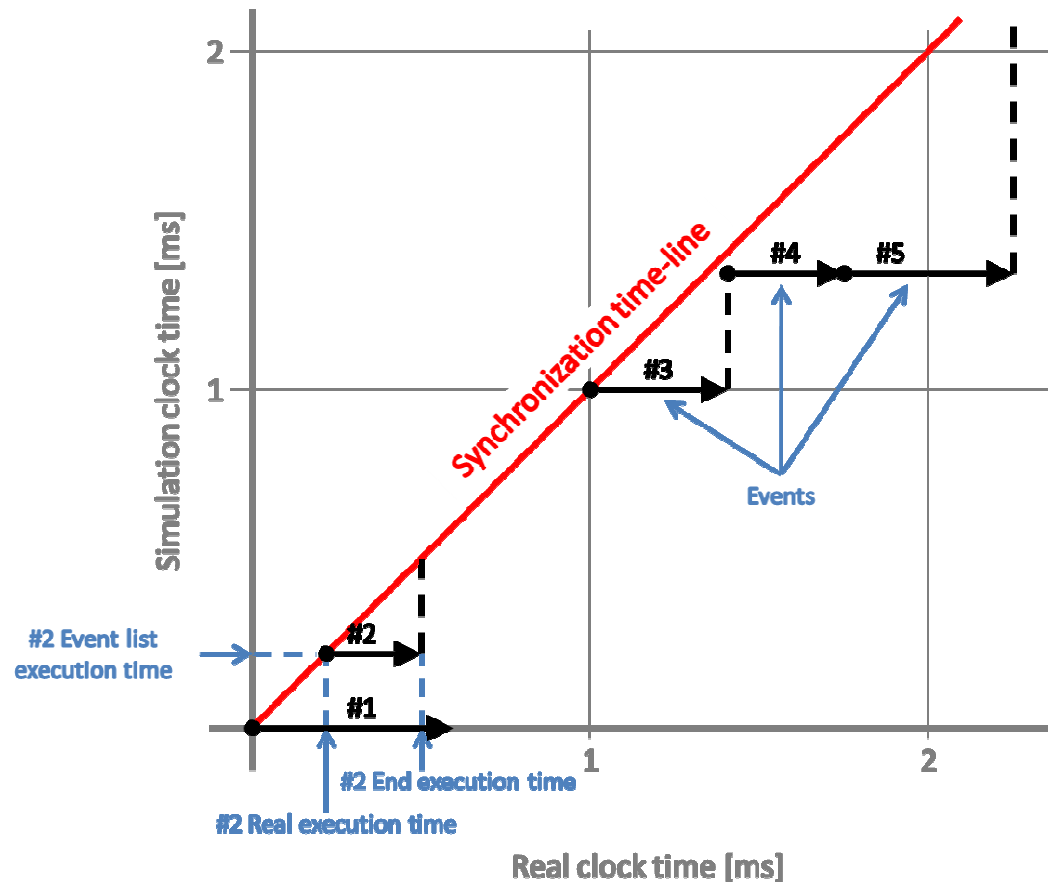

- The main restriction in order to ensure the synchronization between real world and simulation is that the creation time of an event (time at which the event is inserted in the event list) has to be less or equal than the real time to be scheduled.

Advanced Simulation Platform

Simulation Core

- In conclusion, in the existing OMNeT++ infrastructure, the communication with external devices (through sockets) is carried out only in the wait calls, so synchronization problems could easily appear, and hardware-in-the-loop simulations could be invalidated.
- The new simulator core described here, solves these problems by using two processes working in parallel.

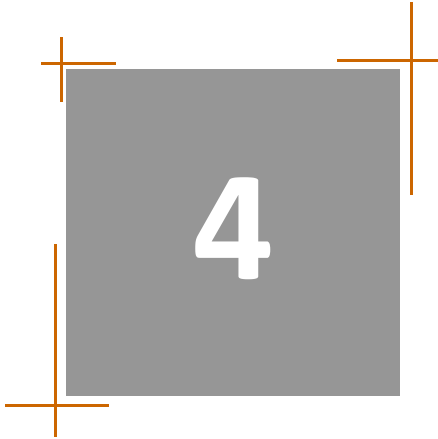

Hardware-in-the-loop simulation



Hardware-in-the-loop simulation

Introduction

- In hardware-in-the-loop simulations, some components are real hardware, and other ones are simulated, normally because they are not available.
- This increases the realism of the simulation and permits evaluation of real developments in a more detailed way.

Hardware-in-the-loop simulation Example

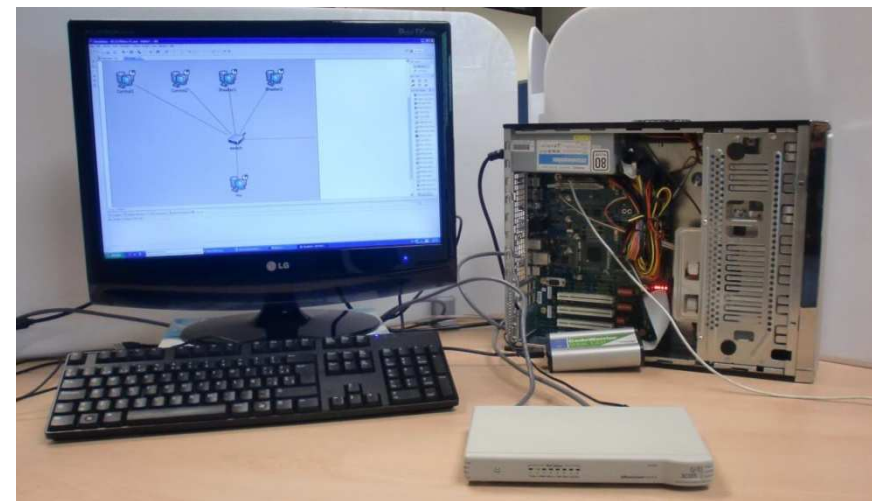
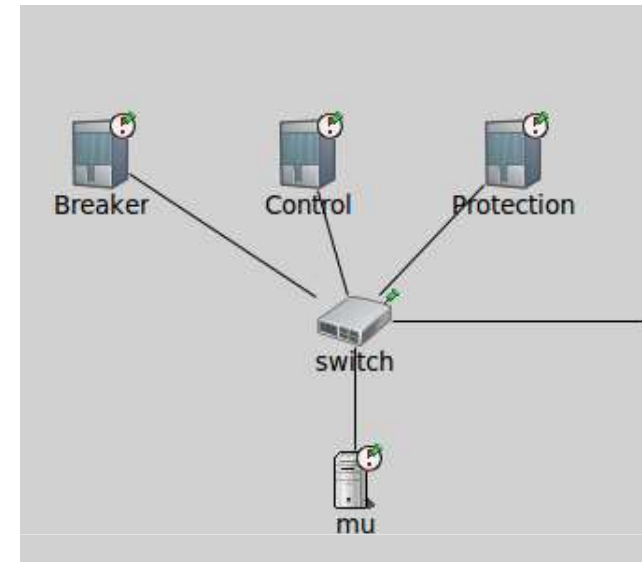
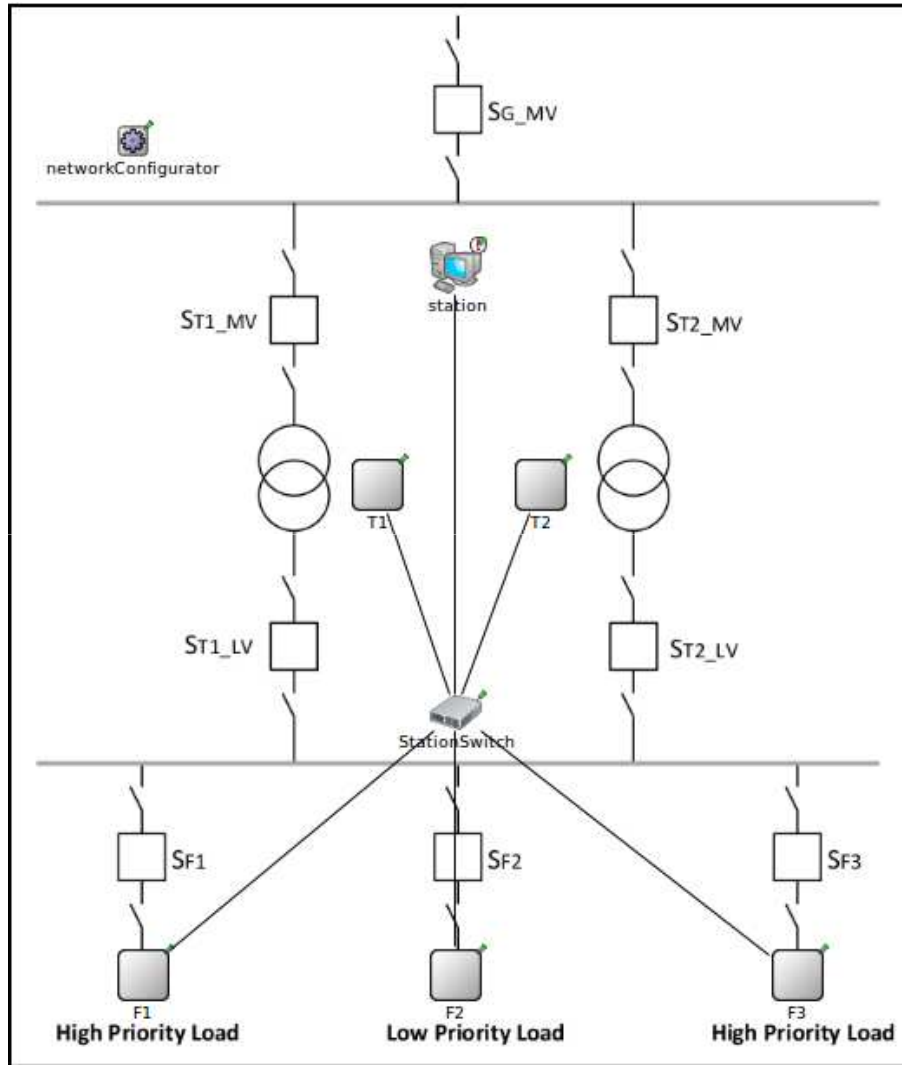

Hardware-in-the-loop simulation

Example

```

+ Frame 6: 96 bytes on wire (768 bits), 96 bytes captured (768 bits)
+ Ethernet II, Src: 00:00:00_00:00:00 (00:00:00:00:00:00), Dst: 00:00:00_00:00:01 (00:00:00:00:00:01)
+ Internet Protocol, Src: 0.0.0.0 (0.0.0.0), Dst: 0.0.0.1 (0.0.0.1)
+ Transmission Control Protocol, Src Port: iso-tsap (102), Dst Port: iso-tsap (102), Seq: 4254497829,
+ TPKT, Version: 3, Length: 42
+ ISO 8073 COTP Connection-Oriented Transport Protocol
+ ISO 8327-1 OSI Session Protocol
+ ISO 8327-1 OSI Session Protocol
+ ISO 8823 OSI Presentation Protocol
- MMS
  - confirmed-ResponsePDU
    invokeID: 1
    - confirmedServiceResponse: identify (2)
      - identify
        vendorName: IIT
        modelName: BCU
        revision: 1.0
  
```

```

0000  00 00 00 00 00 01 00 00  00 00 00 00 08 00 45 00  .....E.
0010  00 52 00 00 00 00 20 06  00 00 00 00 00 00 00 00  .R....
0020  00 01 00 66 00 66 02 c3  55 b1 05 2c d9 8d 50 18  ...f.f..U...P.
0030  ff ff 14 31 00 00 03 00  00 2a 02 f0 80 01 00 01  ...1...*.
0040  00 61 1d 30 1b 02 01 03  a0 16 a1 14 02 01 01 a2  .a.0....
0050  0f 80 03 49 49 54 81 03  42 43 55 82 03 31 2e 30  ...IIT..BCU..1.0
  
```

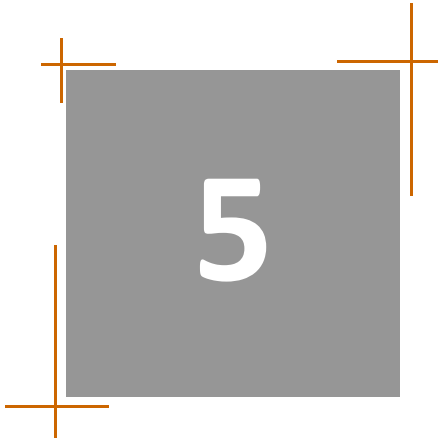

Conclusions

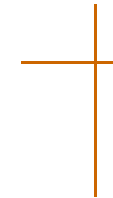

Conclusions

- Most of the previous works about IEC 61850 simulations are focused on the evaluation of the performance of an IEC 61850-based communication network.
- This work presents an advanced simulation platform for IEC 61850-based substation systems.
- With this simulation platform, it will be possible to carry out more advanced simulations (such as hardware-in-the-loop simulations) or simple and fast simulations (such as network performance analysis)
- The two fundamental points of this platform are the newly developed simulation core, which uses two processes working in parallel, and lastly the implementation of the real IEC 61850 stack.



Institute for Research in Technology

C/ Santa Cruz de Marcenado, nº 26

28015 Madrid

Tel +34 91 542 28 00

Fax + 34 91 542 31 76

info@iit.upcomillas.es

www.upcomillas.es

